

wir  verankern
Mauerwerk

nous  ancrons la
maçonnerie

fbk0190-2

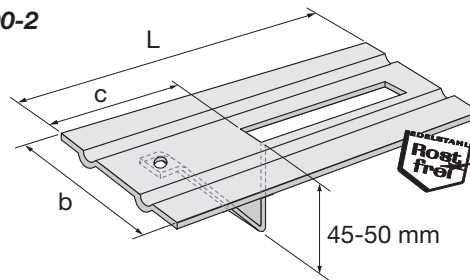

Mauerwerksabfangung für
(temporäre) Leibungen
und Fensterbänke

Console pour embrasure
temporaire et pour tablette
de fenêtre

Typ/type
FBK

Fensterbankkonsolen

Appui pour tablette de fenêtre

Art.Nr. N° d'article	F (kN)	L (mm)	b (mm)	c (mm)	d (mm)	h (mm)	Stück / Karton Pièce / Carton	Preis / Prix Fr. Stk./pce
Material: INOX A2							Matériaux: inox A2	
fbk0190-2	-	190	80	110	-	2	10	12.35

Typ/type
ATC

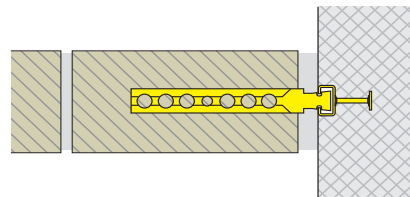
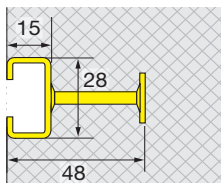

Maueranschluss mit ML-Anker (S.90)
Liaison de murs avec ancre ML (p.90)

Ankerschienen

Rail d'ancrage

Art.Nr. N° d'article	zu Profil pour profilé	Typ type	L (mm)	Preis / Prix Stk./pce
Material: verzinkt				Matériaux: zinqué
atc28150100-f	28 / 15	ATC	100	4.70
atc28150150-f	28 / 15	ATC	150	4.60
atc28150200-f	28 / 15	ATC	200	5.00
atc28150250-f	28 / 15	ATC	250	5.10
atc28153050-f	28 / 15	ATC	3050	41.30
atc2815-f	28 / 15	ATC	per m'	21.05

Material: INOX A4

Matériaux: inox A4

atc28150100-4	28 / 15	ATC	100	15.20
atc28150150-4	28 / 15	ATC	150	15.50
atc28150200-4	28 / 15	ATC	200	17.05
atc28150250-4	28 / 15	ATC	250	17.35
atc28153050-4	28 / 15	ATC	3050	151.90
atc2815-4	28 / 15	ATC	per m'	62.95

Bitte beachten Sie den gültigen LZ resp. TZ (Seite 2)
Diese Preisliste ersetzt alle vorherigen.

Il faut tenir compte du supplément d'alliage actuel, LZ/TZ (voir page 2)
Cette liste de prix remplace les précédentes.

ancotech

ANCOTECH AG
CH-8157 Dielsdorf
Tel: 044 854 72 22
FAX: 044 854 72 29

ANCOTECH SA
CH-1728 Rossens
Tel: 026 919 87 77
FAX: 026 919 87 79

E-Mail:
info@ancotech.ch
Web:
www.ancotech.ch

01. 01. 2019
Seite / page
88

Typ/type

XMS

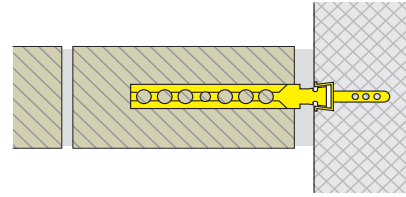
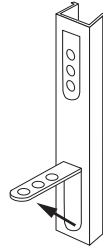
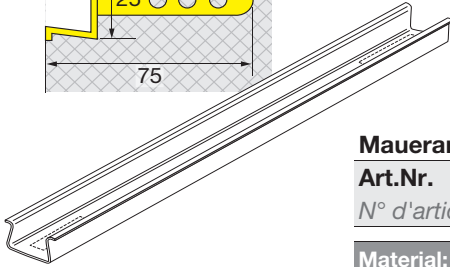
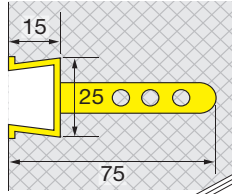

Maueranschluss mit ML-Anker (S.90)
Liaison de murs avec ancre ML (p.90)

Maueranschlussschienen

Rail de raccordement pour murs

Art.Nr. <i>N° d'article</i>	zu Profil <i>pour profilé</i>	Typ / type	L (mm)	Preis / Prix Fr./Stk-pce
Material: verzinkt				Matériaux: zinqué
xms25151250-v	25 / 15	XMS	1250	4.85

Typ/type

XLS

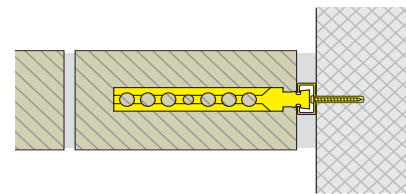
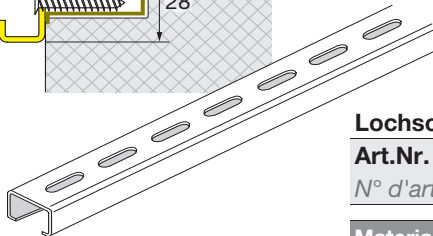
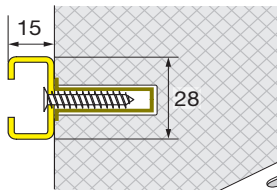

Maueranschluss mit ML-Anker (S.90)
Liaison de murs avec ancre ML (p.90)

Lochschiene

Rails pré-perforé

Art.Nr. <i>N° d'article</i>	zu Profil <i>pour profilé</i>	Typ / type	L (mm)	Preis / Prix Fr.
Material: verzinkt				Matériaux: zinqué
xls28150250-f	28 / 15	XLS	250	Stk./pce 5.20
xls28151250-f	28 / 15	XLS	1250	Stk./pce 13.70
xls28153050-f	28 / 15	XLS	3050	Stk./pce 32.95
xls2815-f	28 / 15	XLS	-	per m' 13.90
Material: INOX A4				Matériaux: inox A4
xls28150250-4	28 / 15	XLS	250	Stk./pce 13.70
xls28151250-4	28 / 15	XLS	1250	Stk./pce 64.05
xls28153050-4	28 / 15	XLS	3050	Stk./pce 152.15
xls2815-4	28 / 15	XLS	-	per m' 48.90

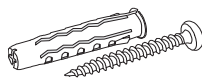

xdg0604020-v	Dübelset à 20 Stk.	Set de douilles à 6 pce.	5.30
xdg06040-2	Dübelset à 6 Stk.	Set de douilles à 6 pce.	5.55
Set à 6 Stk. reicht für ca. 0.75 m		Set à 6 Stk. suffit pour ca. 0.75 m	

Bitte beachten Sie den gültigen LZ resp. TZ (Seite 2)
Diese Preisliste ersetzt alle vorherigen.

*Il faut tenir compte du supplément d'alliage actuel, LZ/TZ (voir page 2)
Cette liste de prix remplace les précédentes.*

wir  verankern
Mauerwerk

nous  ancrons la
maçonnerie

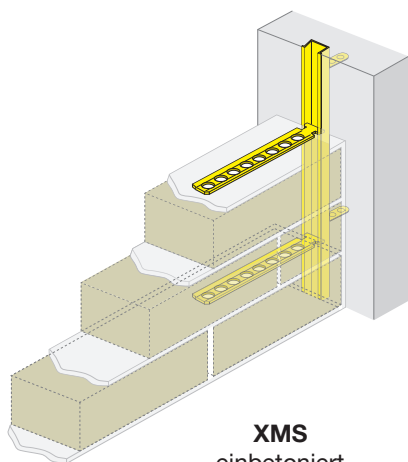

XMS
einbetoniert
rail embétonné

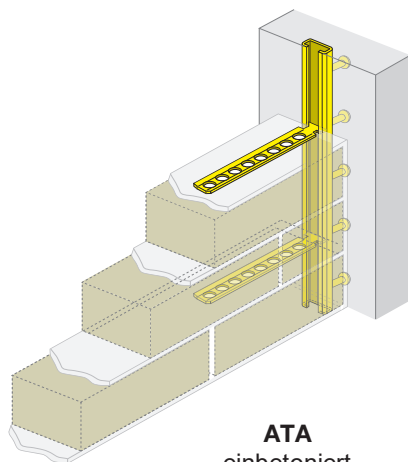

ATA
einbetoniert
embétonné

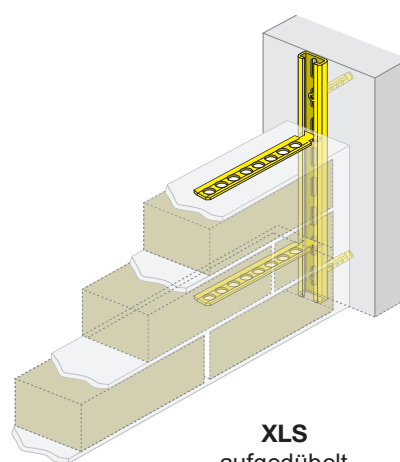

XLS
aufgedübelt
rail fixé avec
cheville

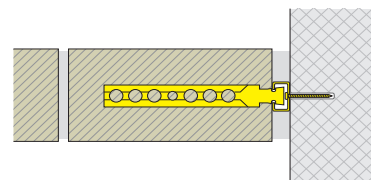
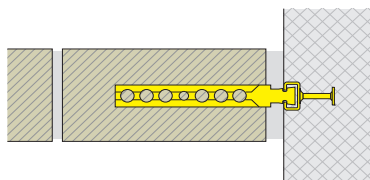
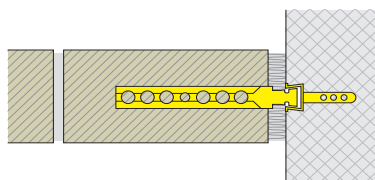

Typ/type

ML

Standard/Standard

Maueranschlussanker

Ancre de raccordement pour murs

Art.Nr. N° d'article	zu Profil pour profilé	a (mm)	L (mm)	h (mm)	Preis / Prix Fr./Stk-pce
-------------------------	---------------------------	-----------	-----------	-----------	-----------------------------

Material: verzinkt **Matériaux: zingué**

ml085-v	25/15, 28/15	26	85	2	0.65
ml120-v	25/15, 28/15	26	120	2	0.80
ml180-v	25/15, 28/15	26	180	2	1.00

Material: INOX A4 **Matériaux: inox A4**

ml085-4	25/15, 28/15	26	85	2	2.55
ml120-4	25/15, 28/15	26	120	2	3.30
ml180-4	25/15, 28/15	26	180	2	4.50

