

**Trittschallelement TSE 36**

**Appuis phoniques pour escaliers TSE36**

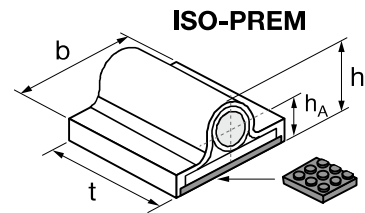
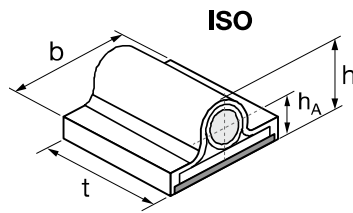
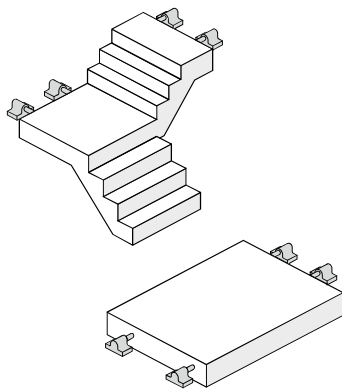

**Isolationshülse**

**Appuis**

Art.Nr. N° d'article	Abmessungen / Dimensions				Preis Prix
	b (mm)	t (mm)	h (mm)	h <sub>A</sub> (mm)	Fr./Stk-pce

**Stahlplatte verzinkt** **Plaque en acier zingué**

tse36iso-k	132	88	76	45	<b>31.10</b>
------------	-----	----	----	----	--------------

**Stahlplatte verzinkt** (Primium-Lager) **Plaque en acier zingué**

tse36isoprem-k	132	88	76	45	<b>52.00</b>
----------------	-----	----	----	----	--------------

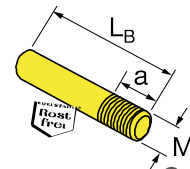
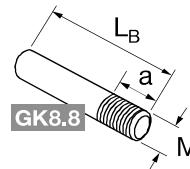
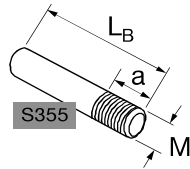
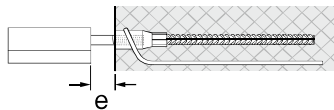

**Bolzen**

**Goujons**

Gewinde Filetage	Abmessungen (mm) Dimensions (mm)			Art.Nr. N° d'article	Preis / Prix Fr./Stk-pce	
	M	a	L <sub>B</sub>			
M36	56		160	0 - 20	tse36b16-v+	<b>18.75</b>
			180	25 - 40	tse36b18-v+	<b>18.85</b>
			190	40 - 50	tse36b19-v+	<b>18.95</b>
			200	50 - 60	tse36b20-v+	<b>19.15</b>
			210	60 - 70	tse36b21-v+	<b>19.25</b>
			220	70 - 80	tse36b22-v+	<b>19.45</b>

S355 verzinkt/zingué	
Art.Nr. N° d'article	Preis / Prix Fr./Stk-pce
tse36b16-v	<b>35.75</b>
tse36b18-v	<b>36.80</b>
tse36b19-v	<b>37.20</b>
tse36b20-v	<b>37.55</b>
tse36b21-v	<b>37.90</b>
tse36b22-v	<b>38.25</b>

GK8.8 verzinkt/zingué	
Art.Nr. N° d'article	Preis / Prix Fr./Stk-pce
tse36b16-4	<b>79.00</b>
tse36b18-4	<b>84.30</b>
tse36b19-4	<b>84.30</b>
tse36b20-4	<b>84.30</b>
tse36b21-4	<b>97.05</b>
tse36b22-4	<b>97.05</b>

inox A4	
Art.Nr. N° d'article	Preis / Prix Fr./Stk-pce
tse36b16-4	<b>79.00</b>
tse36b18-4	<b>84.30</b>
tse36b19-4	<b>84.30</b>
tse36b20-4	<b>84.30</b>
tse36b21-4	<b>97.05</b>
tse36b22-4	<b>97.05</b>

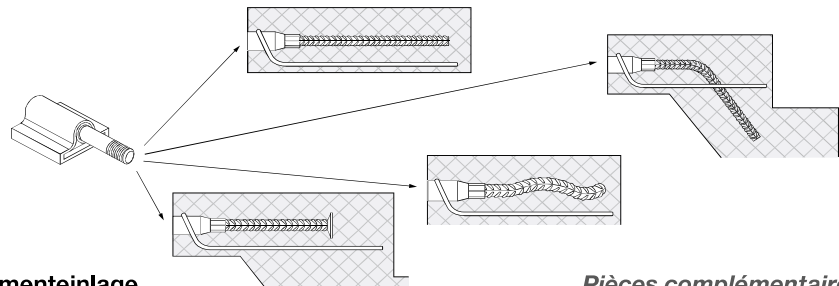

**Elementeinlage**

**Pièces complémentaires**

**Transportanker**

**Ancre de transport**

L (mm)	Art.Nr. N° d'article	Preis Prix
	verzinkt	zingué
690	gta360690-v	<b>11.00</b>
335	ta360335-v	<b>8.65</b>
450	ta360450-v	<b>8.90</b>
380	gtwk360380-v	<b>8.90</b>
570	gtwl360570-v	<b>12.15</b>

Art.Nr. N° d'article	Preis Prix
	inox A4
gta360690-4	<b>71.00</b>
ta360335-4	<b>46.30</b>
ta360450-4	<b>82.25</b>
gtwk360380-4	<b>59.20</b>
gtwl360570-4	<b>82.90</b>

Andere Formen sind auf Anfrage kurzfristig lieferbar

Autres formes disponibles dans un très court délai

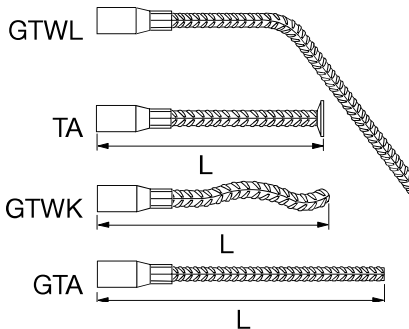

Bitte beachten Sie den gültigen LZ resp. TZ (Seite 2)

Il faut tenir compte du supplément d'alliage actuel, LZ/TZ (voir page 2)

Diese Preisliste ersetzt alle vorherigen.

Cette liste de prix remplace les précédentes.



**ANCOTECH AG**  
CH-8157 Dielsdorf  
Tel: 044 854 72 22  
FAX: 044 854 72 29

**ANCOTECH SA**  
CH-1728 Rossens  
Tel: 026 919 87 77  
FAX: 026 919 87 79

**E-Mail:**  
info@ancotech.ch  
**Web:**  
www.ancotech.ch

**01. 01. 2019**  
Seite / page  
119