

Baubjekt: Projet:		Liefertermin: Date de livraison:	
Bauteil: Partie:		Bestelldatum: Date de commande:	
Plan-Nr.: N° plan:	Liste Nr.: Liste n°:	gezeichnet: Dessiné:	geprüft: Vérfié:
Bauingenieur / Bureau d'ingénieurs:		Lieferadresse / Adresse de livraison:	
Bauunternehmer / Entreprise:			

Trittschallelement TSE 36

Appuis phoniques pour escaliers TSE36

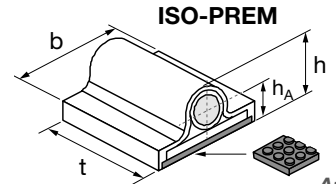
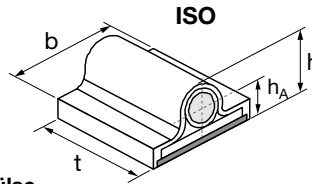
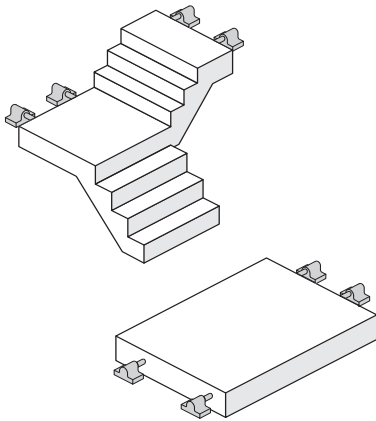

Isolationshülse

Art.Nr. N° d'article	Abmessungen / Dimensions b t h h _A (mm) (mm) (mm) (mm)				Anzahl Quantité (Stk./ pce.)
Stahlplatte verzinkt Plaque en acier zingué					
tse36iso-k	132	88	76	45	
Stahlplatte verzinkt (Premium-Lager) Plaque en acier zingué					
tse36isoprem-k	132	88	76	45	

Appui

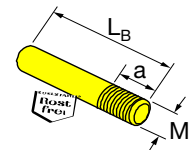
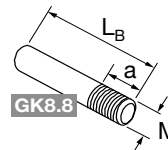
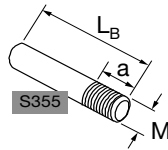
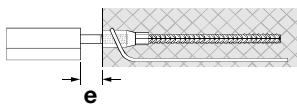

Bolzen

S355 verzinkt/zingué	
Art.Nr. N° d'article	Anzahl Quantité (Stk./ pce.)
tse36b16-v+	
tse36b18-v+	
tse36b19-v+	
tse36b20-v+	
tse36b21-v+	
tse36b22-v+	

GK8.8 verzinkt/zingué	
Art.Nr. N° d'article	Anzahl Quantité (Stk./ pce.)
tse36b16-v	
tse36b18-v	
tse36b19-v	
tse36b20-v	
tse36b21-v	
tse36b22-v	

Goujon

inox A4	
Art.Nr. N° d'article	Anzahl Quantité (Stk./ pce.)
tse36b16-4	
tse36b18-4	
tse36b19-4	
tse36b20-4	
tse36b21-4	
tse36b22-4	

Gewinde Filetage M	Abmessungen (mm) Dimensions (mm)		
	a	L _B	e
M36	56	160	0 - 20
		180	25 - 40
		190	40 - 50
		200	50 - 60
		210	60 - 70
		220	70 - 80

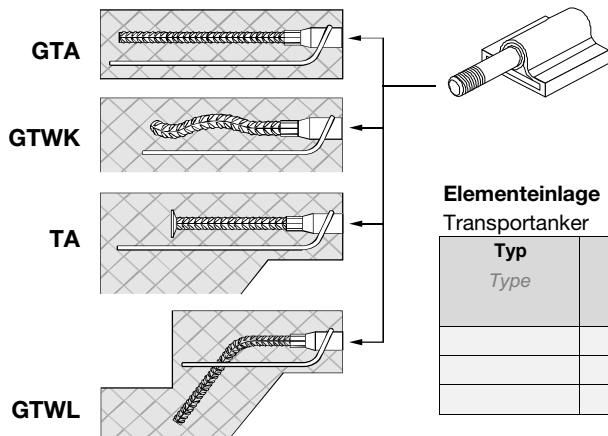

Elementeinlage

Transportanker				Pièces complémentaires Ancres de transport	
Typ Type	Material Materiaux	Zusatzeisen Acier sup. d (mm)	Gewinde Filetage Rd (mm)	Länge Longueur L (mm)	Anzahl Quantité (Stk./ pce.)
		8	36		
		8	36		
		8	36		